

VIVA

3 control landscape thermostatic valve with double diverter (4 outlets)

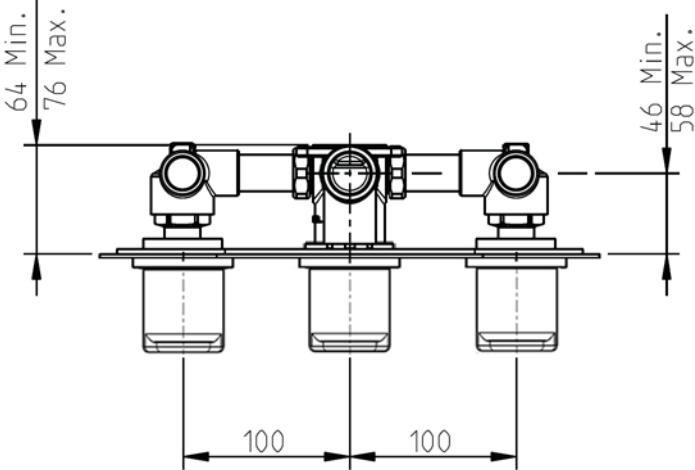
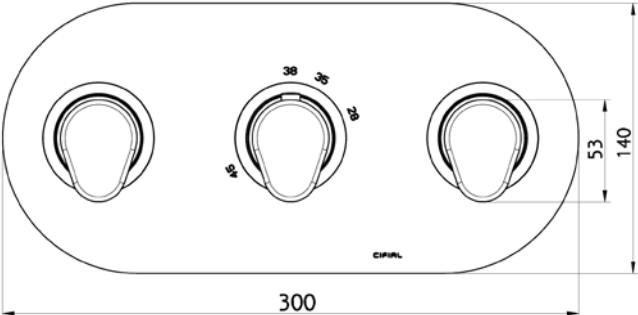

3580018

Válvula Termostática Embutida 3 Furos - 4 Vias
 Concealed Thermostatic Valve 3 Holes - 4 Outlets
 Vendido Separadamente / Sold Separately

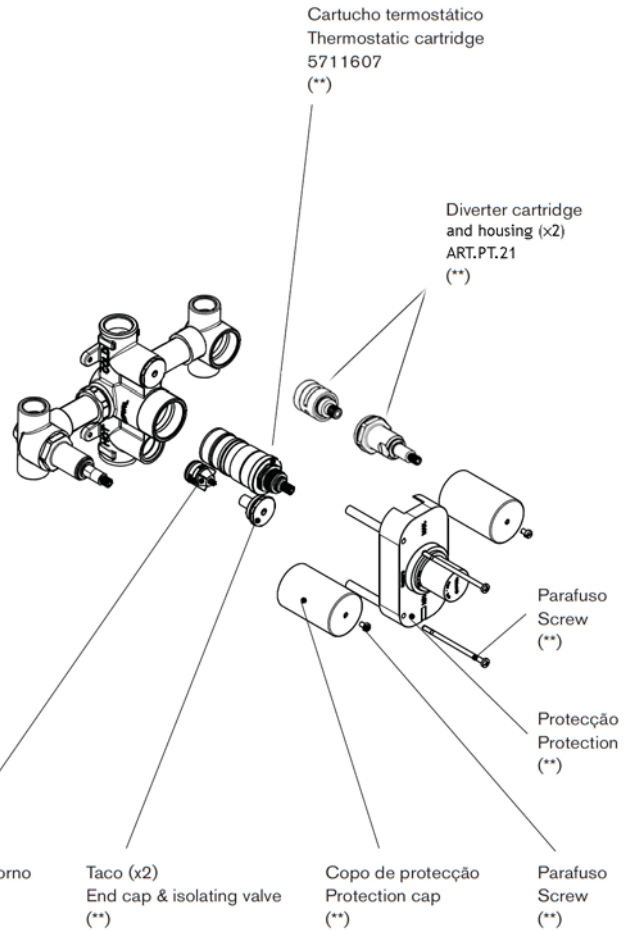

NOTES:

- 1) The red dot on the temperature limit ring must be aligned with the number 38 on the backplate
 - 2) valve rough 3580018 pre-assembled at the factory
- Installer: Please leave all leaflets with the building owner to file for future reference

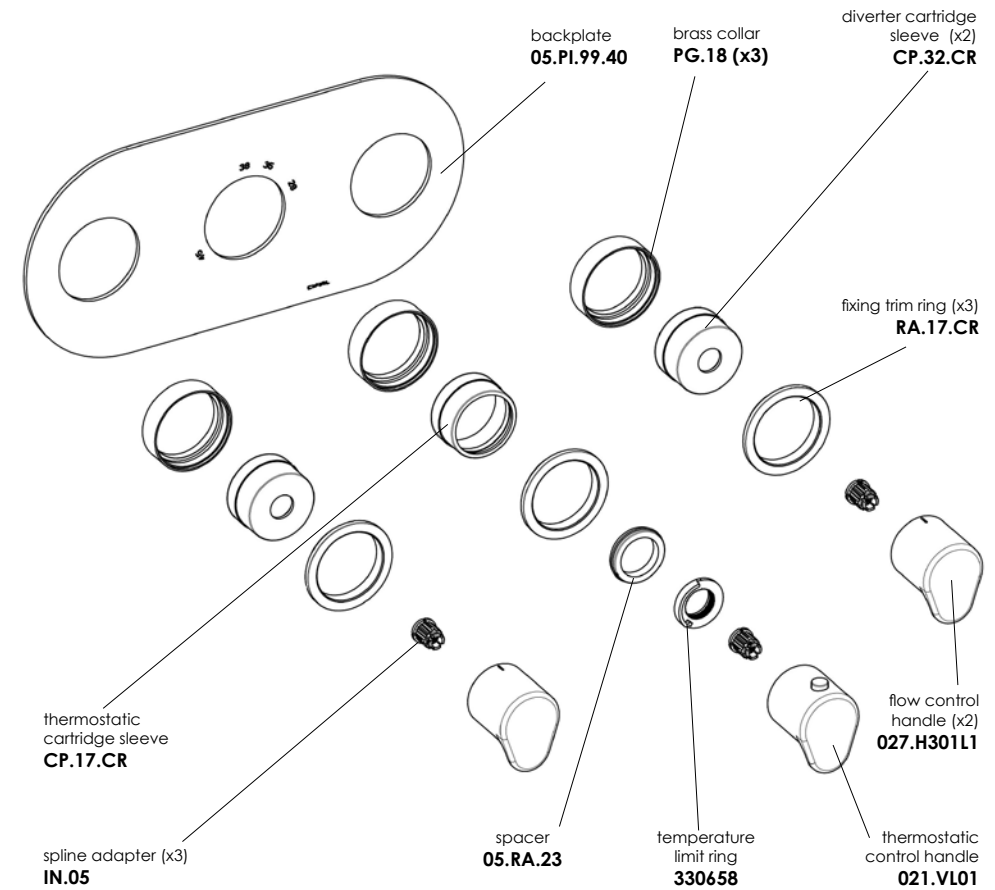

Operation

Requires high pressure (minimum 1.5 bar)

Left Control = on/off and diverter combined
 Lever upright = off
 Lever anti clockwise = mixed water out of bottom outlet (low flow) D
 Lever clockwise = mixed water out of top outlet (high flow) V
NB: You cannot use both left outlets at same time

Middle Control = thermostat with temperature override

Right Control = on/off and diverter combined
 Lever upright = off
 Lever anti clockwise = mixed water out of top outlet (low flow) D
 Lever clockwise = mixed water out of bottom outlet (high flow) V
NB: You cannot use both right outlets at same time

Flow rates

LEFT SIDE FLOW RATES		
BAR	low flow outlet	high flow outlet
1.5	10.7	18.2
2	12.3	21
3	15.5	25.7

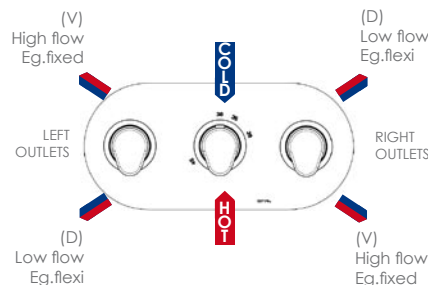

RIGHT SIDE FLOW RATES		
BAR	low flow outlet	high flow outlet
1.5	10.7	18.2
2	12.3	21
3	15.5	25.7

Prior to use - Setting the temperature

1. With both flow controls in the off position, remove the thermostatic valve handle and the temperature limit ring.
2. Put back on the thermostatic valve handle and turn clockwise until the cartridge "clicks". This is now set at fully cold.
3. Turn on one of the flow controls and turn the thermostatic valve handle anti-clockwise until the desired temperature is reached, ie 38°C. Use a thermometer to check if the temperature is correct (Fig. A)
4. Turn off the flow control, remove the thermostatic valve handle and replace the temperature limit ring with the red dot in the 12 o'clock position, ie corresponding with the 38°C on the etched plate (Fig. B).
5. Replace the thermostatic valve handle with the temperature override button position just prior to the 38°C (Fig. C)
6. Your thermostatic valve is now ready for use.

IMPORTANT: it is recommended that on a regular basis you rotate the thermostatic control handle between the maximum and minimum temperature limits by pressing the override button and with the water running. This way you prevent limestone incrustation that could build up and block the thermostatic cartridge.

Fig. A

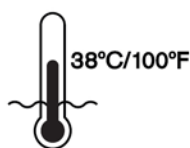

Fig. B

Red mark aligned with the mark 38°C.

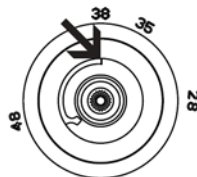

Fig. C

Temperature override button

